

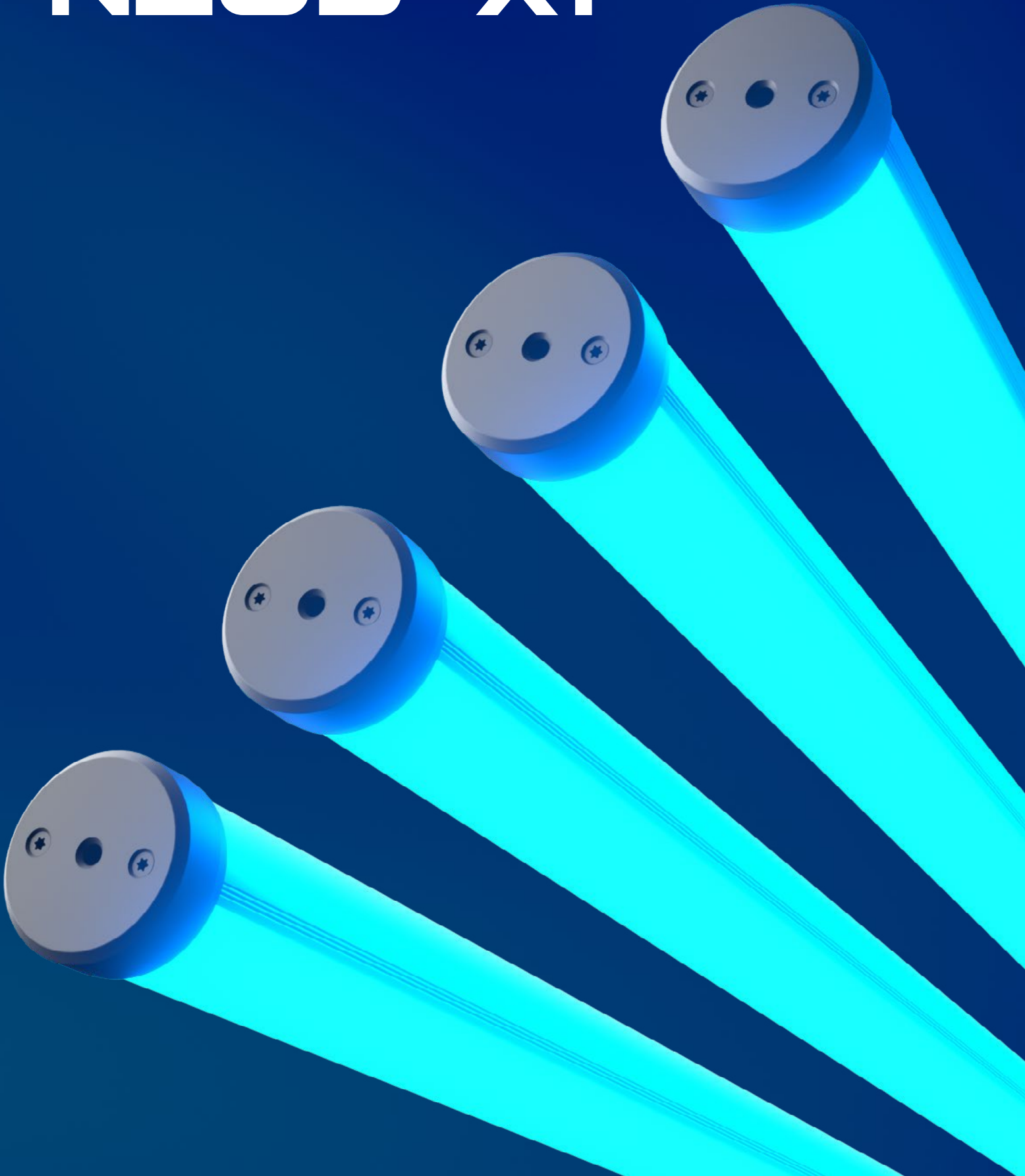

NEOS X1





NEOS X1

Sagitter expands its range of battery-powered products with **Neos X1**, a perfect blend of design, technology, and versatility dedicated to creative professionals. The ideal tool for filmmakers, television studios, and exclusive events.

OPTICAL SYSTEM

One of Neos X1's standout features is its special front opal diffuser, designed to distribute the LED light source evenly, faithfully recreating the effect of a soft, shadow-free neon glow. This type of illumination is ideal for modern designs and specific scenographic setups.

LED SOURCES

Equipped with 320 RGB+Amber+Mint LEDs, Neos X1 delivers an exceptionally wide color gamut and a CRI ≥ 95 , essential requirements for applications demanding accurate color reproduction and light output as close as possible to natural illumination.

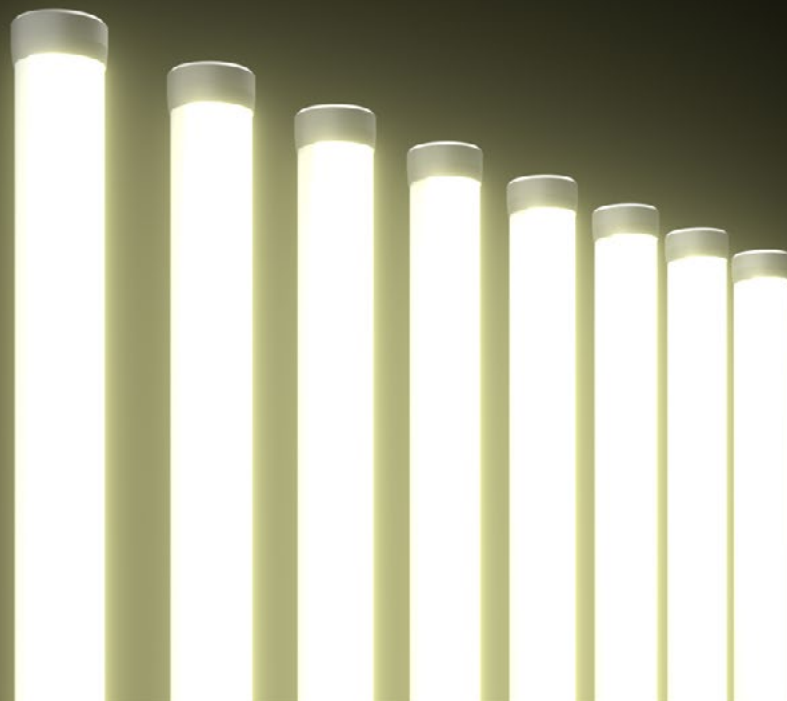



DESIGN

Neos X1 features an aluminum housing, a material highly valued for its combination of strength and lightweight construction, as well as its excellent heat dissipation properties. This ensures optimal operating temperatures and long-lasting, consistent LED performance.

WEATHER RESISTANCE

The IP54 rating ensures that Neos X1 is protected against dust and water splashes from any direction, making it suitable for both indoor and outdoor use, even in unpredictable weather conditions.

CONTROL

The COLOR button has been designed to provide operators with fast and intuitive access to color temperature adjustment, integration with LEE Filters color libraries, more than 101 COLOR MACROS, and STATIC COLOR mode.

Dynamic effects and preset macros allow users to quickly transform atmospheres, adapting to any situation—from live shows and artistic performances to immersive installations. Thanks to its 16-zone pixel mapping capability,

complex and customized lighting effects can be created, making it the perfect choice for professionals looking to captivate their audience.

The integrated wireless DMX receiver enables advanced control without the need for additional cables, particularly useful in applications requiring rapid setup and remote fixture management.



TECHNICAL SPECIFICATIONS

ORDERCODE: SG NEOSX1

Light Source

320 × 0.5W RGB+Amber+Mint LEDs (64R – 64G – 64B – 64A – 64M)

LED source lifespan: >50,000 hours

LED refresh rate: >15 kHz, flicker-free

CRI ≥ 95 Ra

Optics

Beam angle: 135° × 115°

Color System

RGB+Amber+Mint LED source (64R – 64G – 64B – 64A – 64M)

Unlimited color possibilities

Effects

Linear dimmer 0–100%

Adjustable strobe effect

16-zone pixel control

Control and Programming

7 available DMX configurations: 2/3/5/12/48/80/87 channels

USITT DMX512 signal control

Built-in wireless DMX transceiver

APP Vision Control

Static Color mode

Automatic modes with 30 selectable programs and adjustable speed via onboard display

Virtual color wheel with 101 macros

Virtual white wheel with 112 macros

Customizable color calibration system

Power management system with 4 selectable dimming curves

Housing and Construction

Die-cast aluminum alloy housing

Full-color LCD graphic display

Front opal acrylic diffuser

IP54 protection rating

1/4"-20 UNC threaded mounting point

Power Supply

Input voltage: 18VDC – 5A

Internal rechargeable battery: 14.4VDC, 6400mAh

Battery runtime: approximately 1h 45m (Full On – Boost Power)

Battery runtime: approximately 3h 50m (Color Change – Boost Power)

Charging time: approximately 6 hours (fixture switched off)

Universal switching power supply

Maximum power consumption: 70W

External power supply included:

Input: AC 100–240V, 50/60Hz

Output: 18VDC – 5A

Weight and Dimensions

Net weight: 1.35 kg

Dimensions: 1060 × Ø 44 mm



LED SOURCE

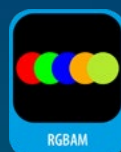

RGBAM



BATTERY POWERED



WIRELESS DMX



VISION CONTROL



IP54

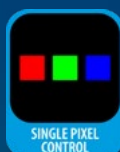

SINGLE PIXEL CONTROL



COLOUR WHEEL



TUNEABLE WHITE



CALIBRATION CHIP



STROBE EFFECT



AUTO MODES



FLICKER FREE



EMERGENCY LIGHT

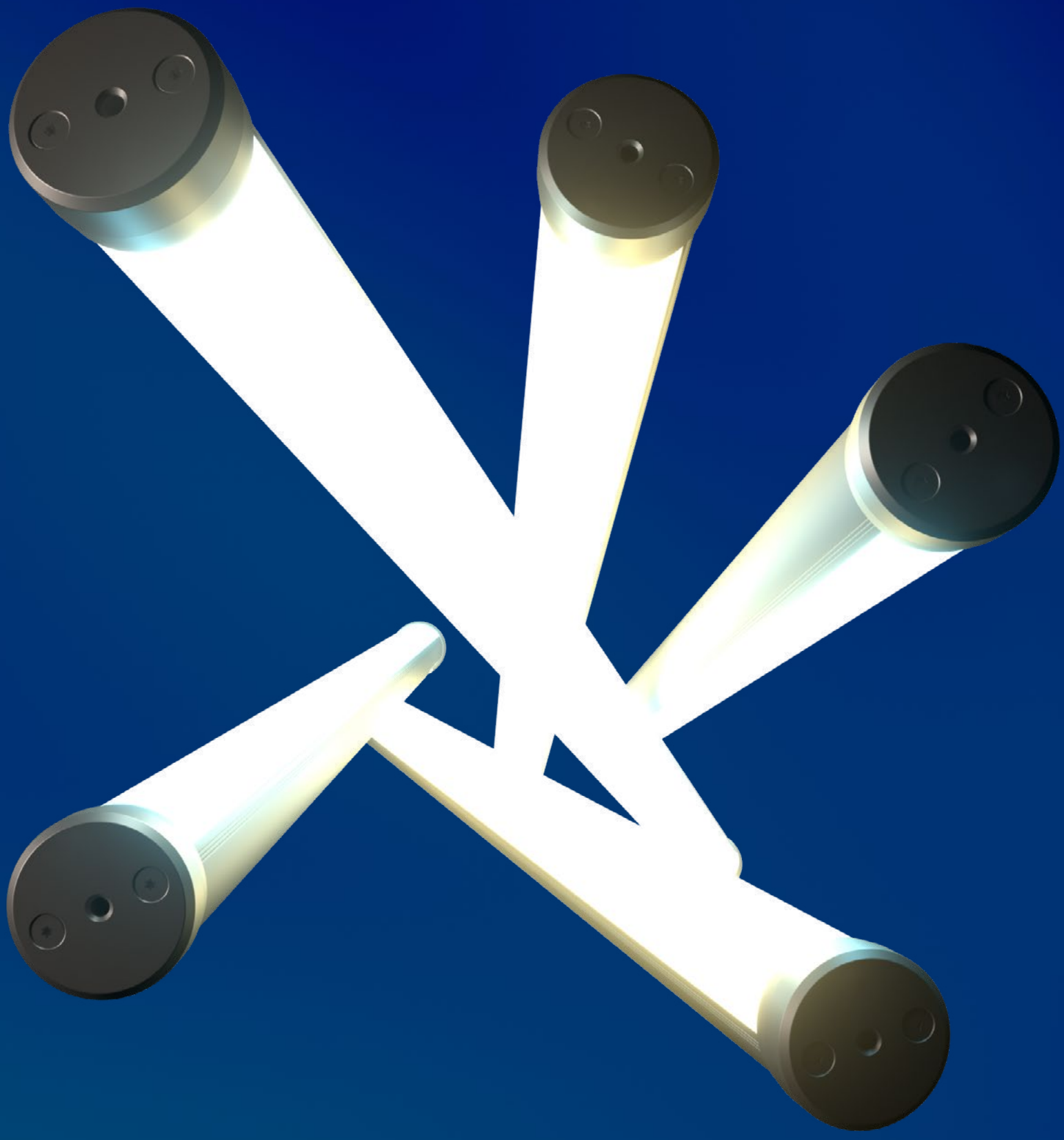

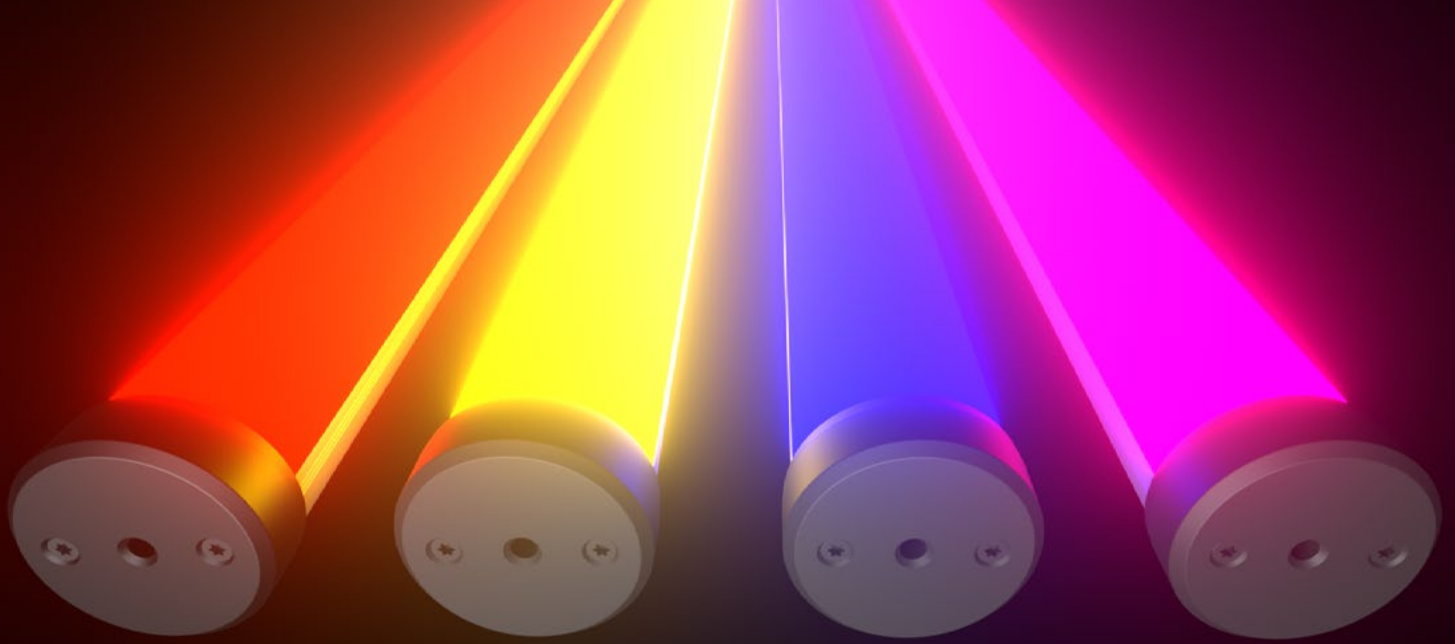

CONTROL SYSTEMS

Neos X1 can be controlled via Wireless DMX (WDMX protocol) and through Vision Control technology. The optional WECONHUB system integrates both Wireless DMX and Vision Control technologies, enabling simple and coordinated management across a wide range of applications. It streamlines system setup and configuration while ensuring flexible and efficient operation. WECONHUB can function as both a transmitter (TX) and receiver (RX), is battery-powered, and features adjustable antennas for maximum convenience.

ORDER CODE: SG WECONHUB





Vision Control

APP CONTROL

To make control accessible to everyone, Neos X1 integrates wireless connectivity with the dedicated VISION CONTROL app. Thanks to its intuitive interface, users can easily monitor and adjust every parameter of the fixture, create static scenes, and design complex dynamic effects with a simple touch—without the need for cables or bulky controllers. This allows both professionals and less experienced users to work with ease, creativity, and precision.

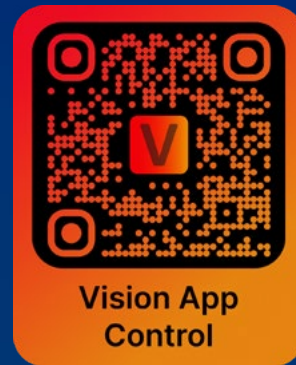

VISION CONTROL CONNECTION DIAGRAM

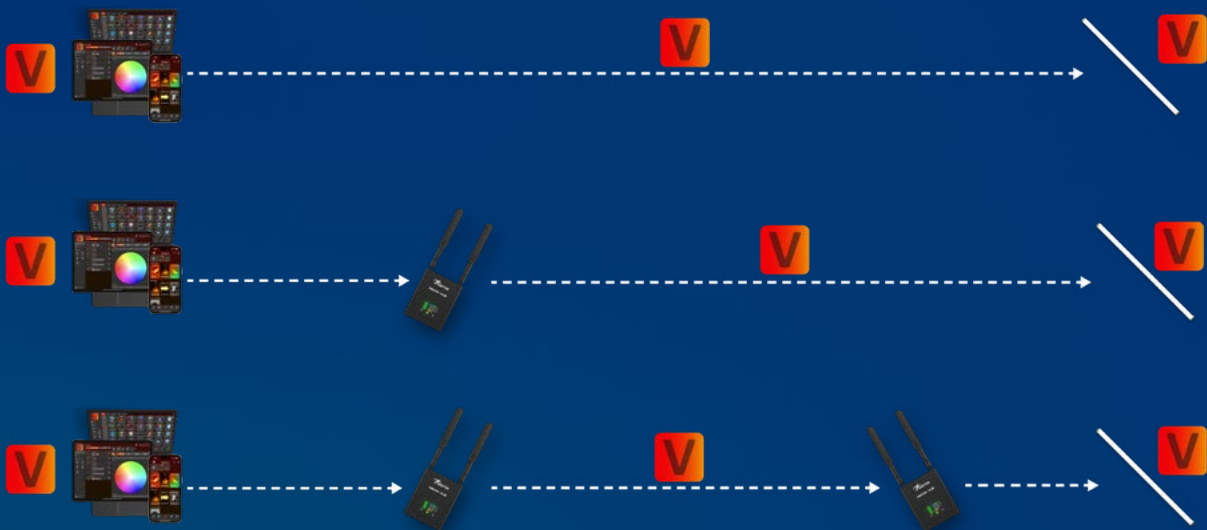

FLEXIBILITY OF USE

The wide range of optional accessories makes NEOS X1 the ideal tool for professionals seeking creative, flexible, and easy-to-use lighting solutions. The integrated battery ensures maximum versatility, eliminating the need for cumbersome cables and allowing operation in virtually any location, even in hard-to-reach environments. On film sets, this feature is particularly valuable for creating fast and adaptable lighting setups.

NEOS STAND

ORDERCODE: SG NEOSSTAND

A sturdy and compact aluminum tripod stand designed to provide stable support for the NEOS X1. Its foldable structure allows quick setup and breakdown, making transportation and storage easy and convenient.



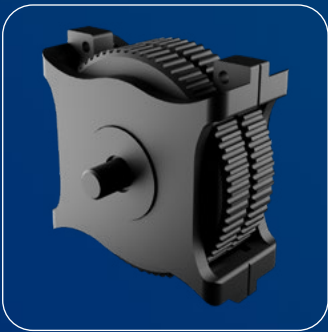

**NEOS CONNECTION
KIT 1**

ORDERCODE: SG NEOSCON1

180° 2-way connector



**NEOS CONNECTION
KIT 2**

ORDERCODE: SG NEOSCON2

90° 2-way connector



**NEOS CONNECTION
KIT 3**

ORDERCODE: SG NEOSCON3

4-way connector

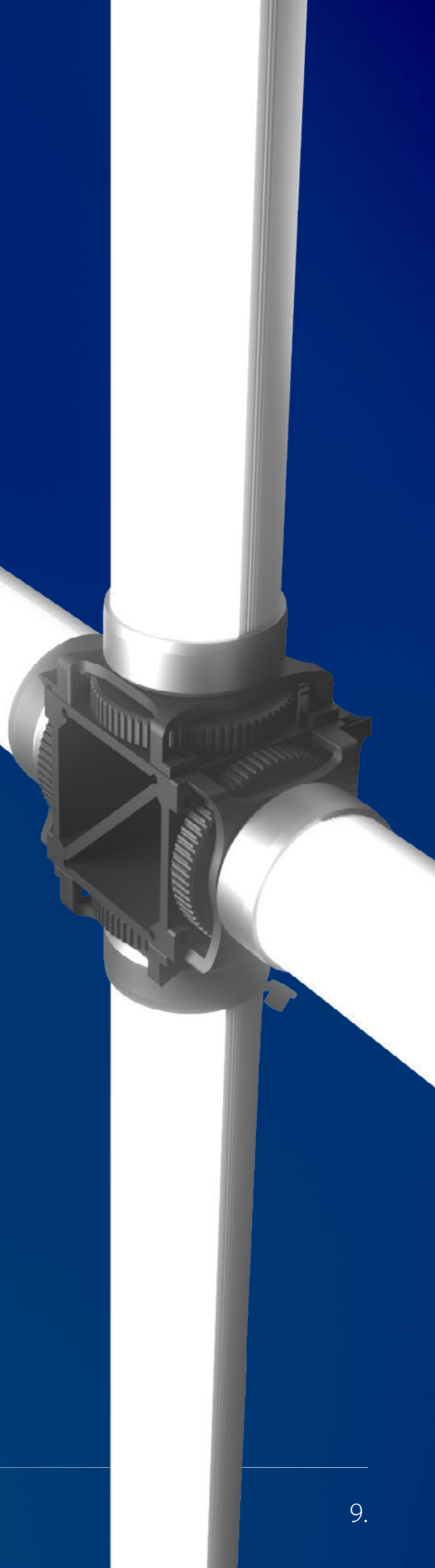

NEOS CLAMP T

ORDERCODE: SG NEOSCLAMPT

Multifunction metal bracket featuring a quick-release Omega-type clamp and two SG NEOSCLAMP magnetic quick-release clamps.

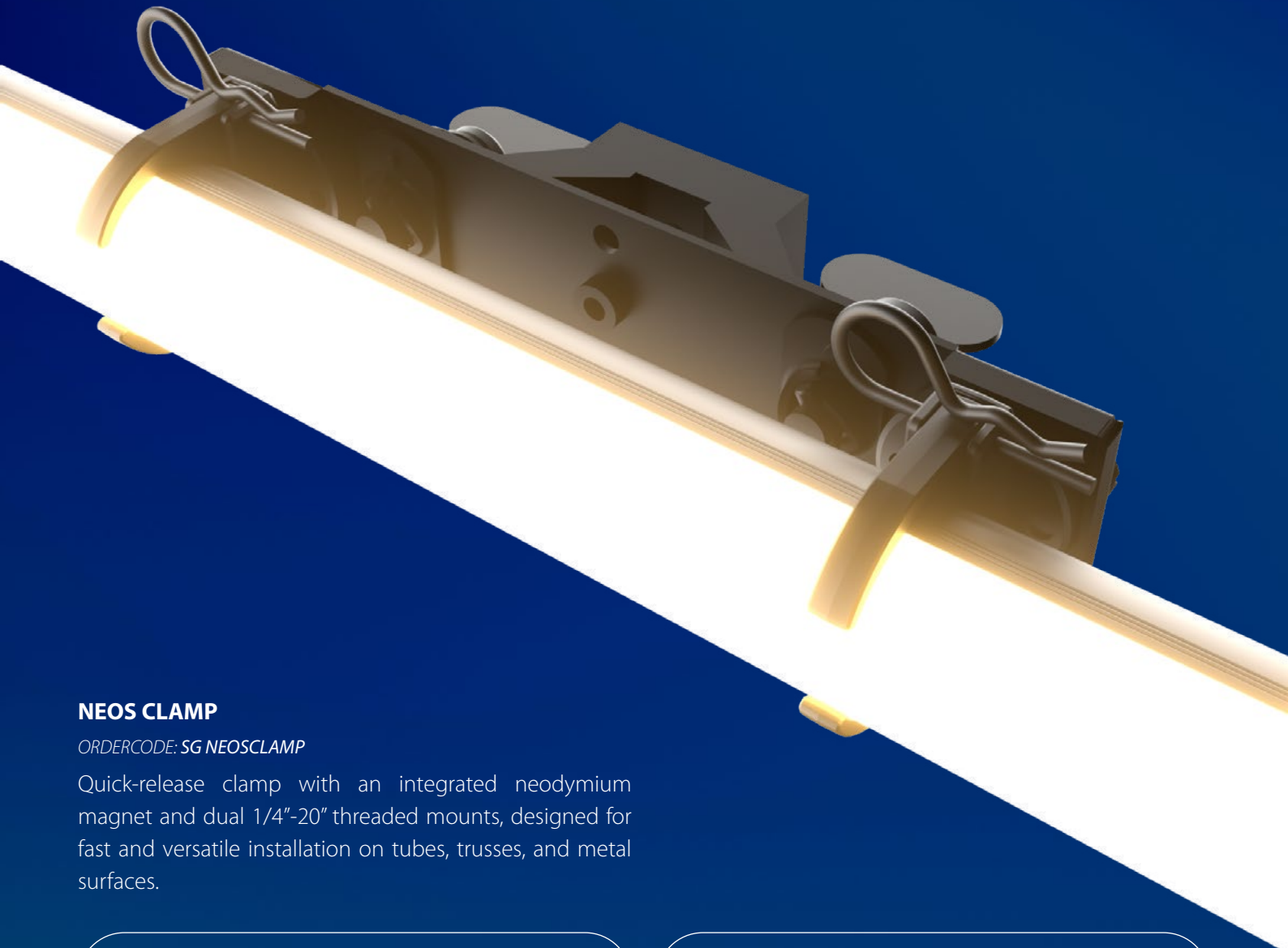

NEOS CLAMP

ORDERCODE: SG NEOSCLAMP

Quick-release clamp with an integrated neodymium magnet and dual 1/4"-20" threaded mounts, designed for fast and versatile installation on tubes, trusses, and metal surfaces.



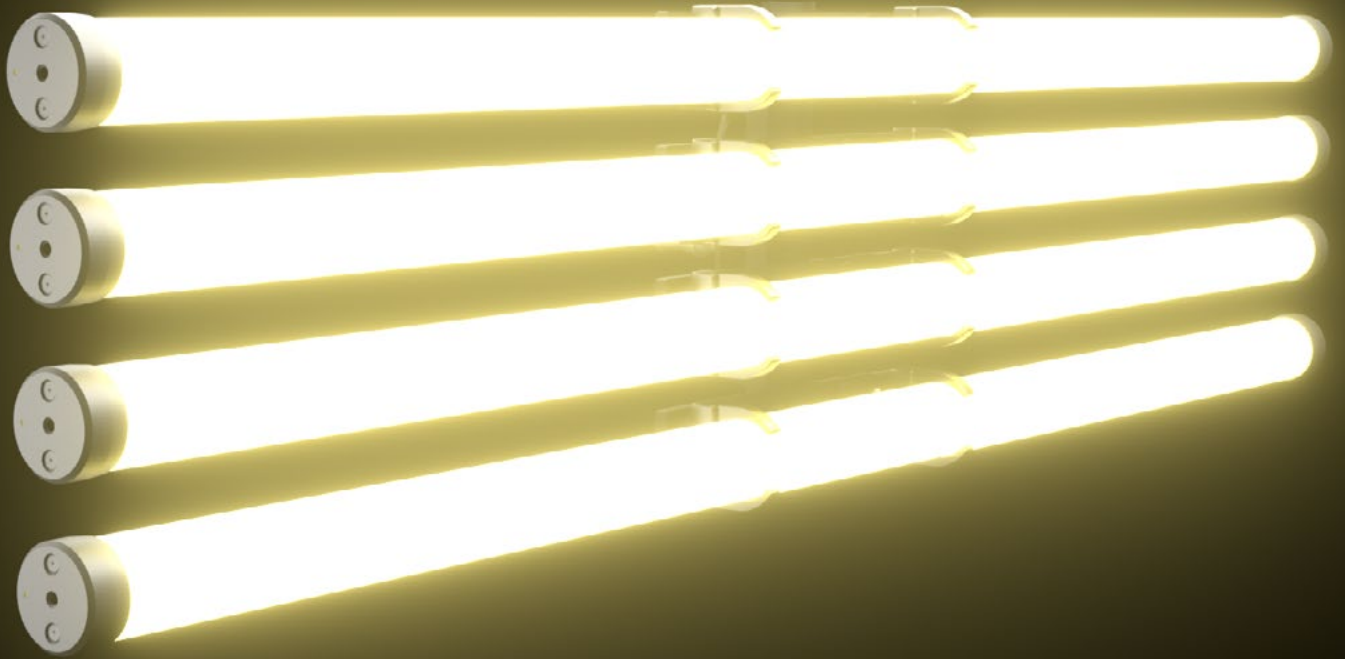

NEOS CLAMP X

ORDERCODE: SG NEOSCALMPX

Connection bracket for four SG NEOSCLAMPT units.
Includes a quick-release mounting bracket.

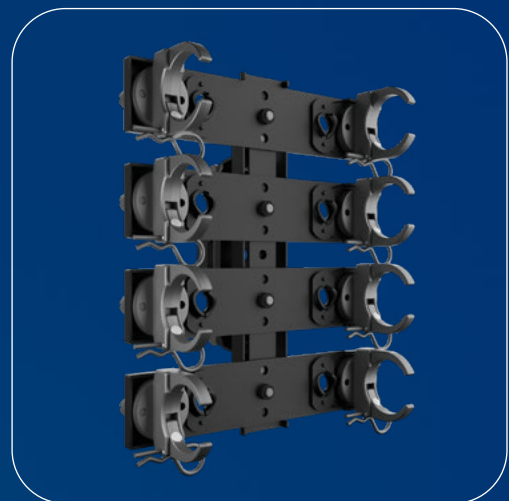

NEOS X1 is compatible with dedicated accessories that further expand its installation possibilities in professional environments. In particular, long pins and short pins are available for use with standard mounting systems such as Grip Heads and Super Clamps.

These accessories enable fast, secure, and flexible mounting on technical structures, trusses, and scenic supports, ensuring stability and adaptability to meet a wide range of installation requirements.

NEOS LONG PIN

Long aluminum spigot with 1/4"-20 male threads



ORDERCODE:
SG NEOSPINL

NEOS SHORT PIN

Short aluminum spigot adapter with 1/4"-20 and 3/8"-16 male threads



ORDERCODE:
SG NEOSCALMPX



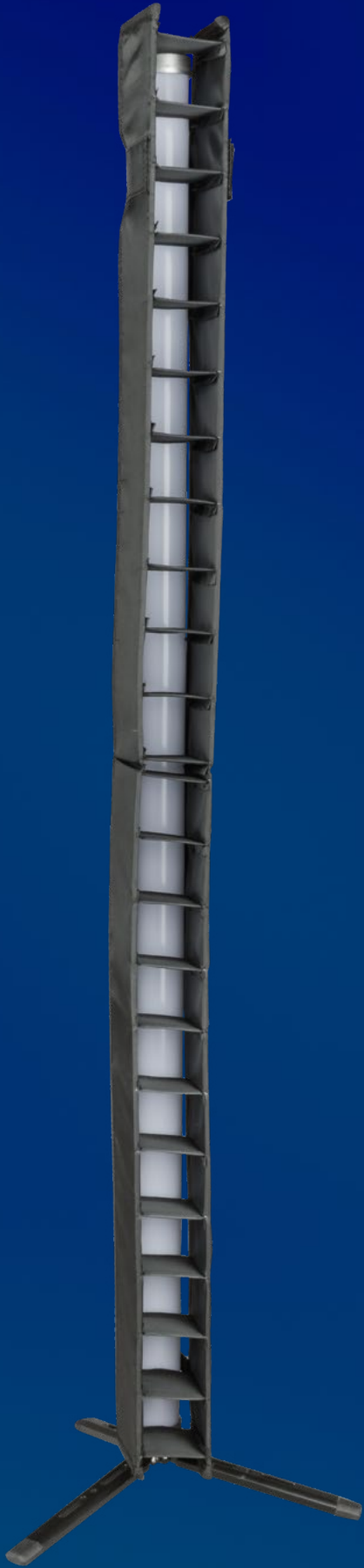

NEOS GRID 100

ORDERCODE: SG NEOSGRID100

Collapsible elastic fabric grid that folds in half and features a tie-fastening system.

It allows precise control of light spread, reduces spill light, and helps define the illuminated area while maintaining maximum portability and ease of installation.



POWER HUB 183508

ORDERCODE: SG PH183508

Integrated charging system featuring 8 dedicated outputs and powerCON TRUE1 IN/OUT connectors for daisy-chain operation.

It allows simultaneous charging of up to 8 tubes or continuous power supply to 4 tubes, providing a convenient and centralized solution for users operating multiple fixtures.

This is particularly advantageous in professional environments such as photography studios, film sets, and live events where uninterrupted operation is essential. It is also ideal for permanent installations requiring a stable and reliable power source, eliminating downtime caused by frequent battery recharging.

The system includes an omega bracket for hanging installation and 8 charging/power cables.



Omega clamp included

NEOS POWER EXTENSION

ORDERCODE: SG NEOSPWR3 - SG NEOSPWR5

Extension cables are available in 3 m and 5 m lengths.





NEOS BAG

ORDERCODE: SG NEOSBAG100

TRANSPORT SOLUTION

A rugged wheeled transport case made from polypropylene (PP) has been specifically designed to safely transport 8 tubes complete with accessories.

Its lightweight yet durable construction, integrated charging system, and optimized internal organization make it an essential tool for professionals who require efficient transportation and deployment of their equipment.

BATTERY RUNTIME

We understand how important it is for users to know the actual operating time of the system during use.

The chart below provides an estimated battery runtime based on different color combinations and operating modes, including Full Power, Single Colors, RGB/Amber/Mint Mixes, and Color Change modes.

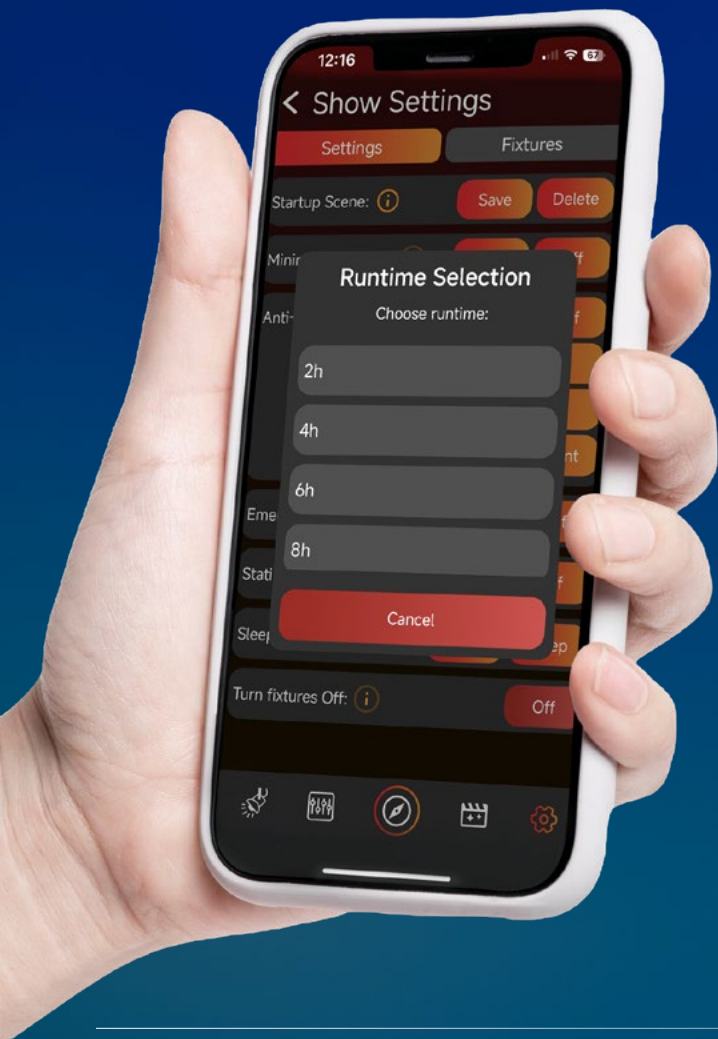
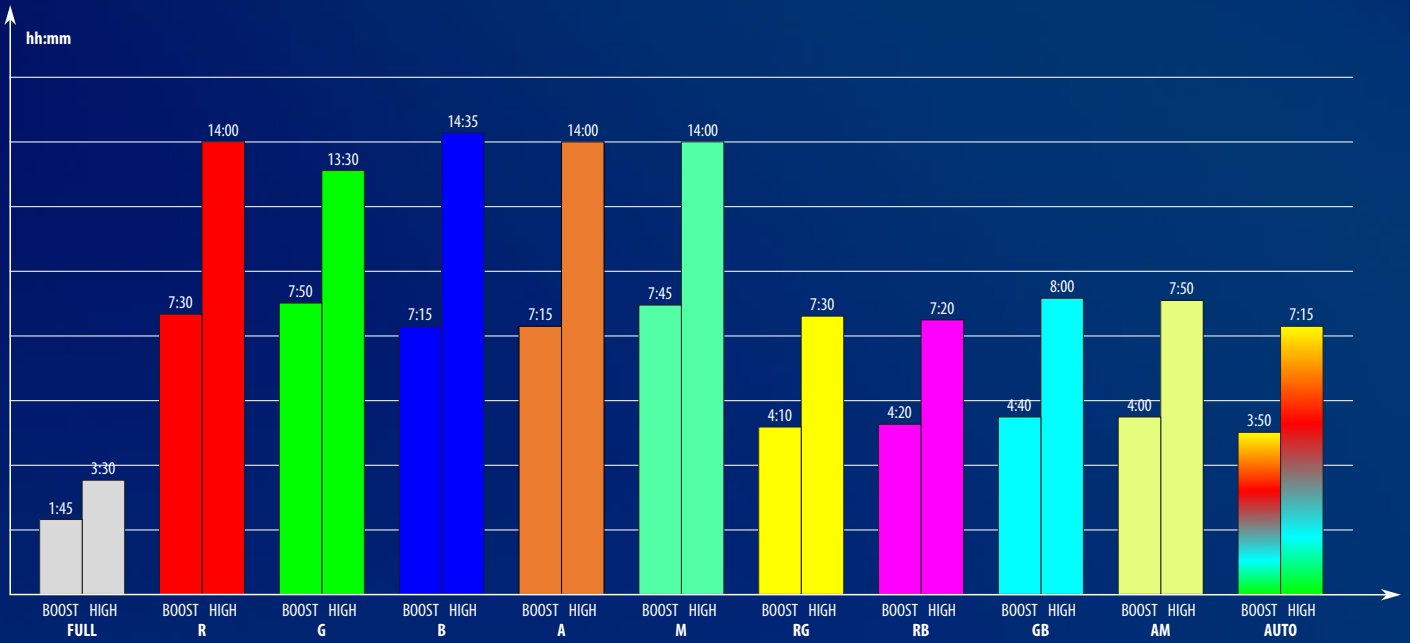

SMART BATTERY RUNTIME

The values shown in the chart should be considered reference estimates based on standard operating conditions and are intended to compare the energy consumption of different operating modes.

Actual runtime may vary depending on usage profile, intensity levels, active effects, and battery condition.

To address this variability, the Vision Control app features a dynamic runtime estimation system that continuously updates the remaining battery life in real time according to the fixture's actual power consumption.



SMART POWER MODES

To provide maximum versatility, Neos X1 offers a wide operating power range suitable for any working environment, with four different operating modes.



1. The AC Failure function allows the fixture to automatically continue operating in the event of a power outage while connected to the mains supply, ensuring uninterrupted operation and enhanced reliability in critical applications.



2. When Neos X1 is connected to an external power supply, the Cut-Off function helps preserve battery life by preventing continuous charging and discharging cycles. This intelligent power management strategy optimizes energy handling and reduces battery stress during extended AC-powered operation. The fixture's behavior automatically adapts according to LED status and function settings, ensuring efficient management of both charging and power distribution.



3. Battery Off Mode allows the fixture to operate exclusively from AC power when the battery is physically disconnected. The fixture automatically powers on when input voltage is detected.

Together, these three functions create a comprehensive and flexible power management system designed for continuous operation, emergency applications, and permanent installations, improving efficiency, reliability, and battery longevity.

BATTERY MANAGEMENT SYSTEM (BMS)

The integrated Battery Management System (BMS) is the core of Neos X1's intelligent power management architecture.

It continuously monitors and optimizes battery operation, ensuring operational safety, consistent performance, and maximum efficiency.

Through advanced control of energy parameters, the BMS protects the system from critical operating conditions, extends battery lifespan, and guarantees reliable performance even during intensive and prolonged use.

An invisible yet essential technology that delivers stable, efficient, and always-ready power for professional lighting applications and event production environments.









is a brand of **PROEL SPA**
(Worldwide Headquarters)

Via alla Ruenia, 37/43 - 64027 Sant'Omero (TE) - ITALY

Tel. +39 0861 81241 - Fax +39 0861 887862

P.I. 00778590679

N.Reg.AEE IT 0802000002762

sagitter.com